

DETC2006-99059

IGM-Mechanism Encyclopaedia and the Digital Mechanism Library as a Knowledge Base in Mechanism Theory

Burkhard Corves, Jürgen Niemeyer and Johannes Kloppenburg

Institut für Getriebetechnik und Maschinendynamik
RWTH Aachen University
Eilfschornsteinstrasse 18, D-52062 Aachen, Germany

INTRODUCTION

The Institute of Mechanism Theory and Machine Dynamics of RWTH Aachen University houses a large collection of more than 200 mechanisms and models. Partly they are used to illustrate and visualize kinematic basics and methods taught to students. Furthermore these models are also used as a basis for mechanical designers looking for a solution to their motion tasks in different machinery such as packaging or processing machines. These models span a wide arch from historic models showing e.g. sewing machines from the late 19th century, typewriters from the early 20th century and acrylic glass models still used today in university lectures where they are placed on the overhead projector. With the swift development of the internet as the major base for information retrieval, new ideas about knowledge presentation have come up. Today it is obvious that fast and easy access to information is a major success factor in most areas both economics and science and is therefore of eminent importance. New developments in information technology and related software have created new possibilities for the presentation of scientific knowledge also in mechanism theory [1]. In this paper the IGM-Mechanism Encyclopaedia and the Digital Mechanism Library will be presented. Both use the possibilities of the internet to make basic and specific knowledge for the analysis and synthesis of mechanisms available to a broad public.

Even though the knowledge about mechanism science is indispensable not only in mechanical engineering, only the basic methods regarding type synthesis, kinematic synthesis and analysis are usually taught in engineering education. For the future this situation will not improve due to the ever increasing scope of new technologies and developments in all engineering areas, which become ever broader and more

interdisciplinary. Today computer and IT science plays an ever increasing role in mechanical engineering education thus decreasing the time available to teach classic subjects such as mechanism theory.

The existing extensive knowledge in mechanism theory today is available to the public only on a very limited basis. This does not meet today's requirements of a fast and efficient information retrieval. The available technical literature (science books, scientific journals, mechanism catalogues and congress proceedings) often is no longer adequate according to today's requirements regarding content and media presentation. Also the ever increasing urge from industry but also from research institutions to be able to access knowledge about mechanism theory via internet because of a lack of selected experts in mechanism theory has put pressure on serving those needs. Additionally ancient and solitary knowledge inventories must be tapped, digitally enhanced and interconnected. The IGM-Mechanism Encyclopaedia and its larger cousin, the Digital Mechanism Library are an attempt to fill that gap.

1 DESIGN PROCESS FOR MOTION DEVICES

The design process for motion devices is similar to the general design process for technical products and can be subdivided according to a systematic approach [2]. As a result concepts have been developed in the past, which allow describing the design process systematically from the idea up to the final product [3, 4]. Common to all these concepts is the classification of the work progress as shown in **Fig. 1**. The same principal approach can also be used for the layout of mechanisms [5].

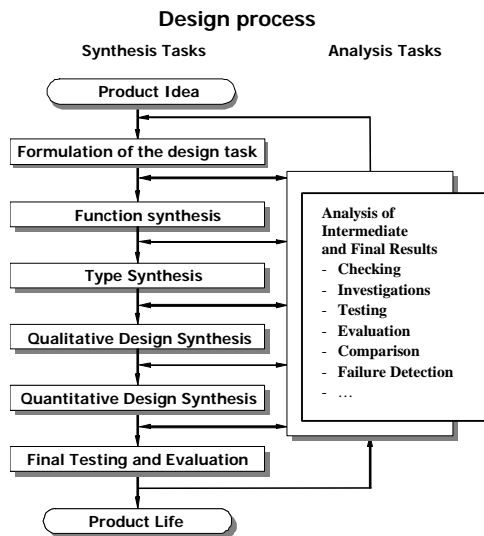

Fig. 1. General concept of a design process

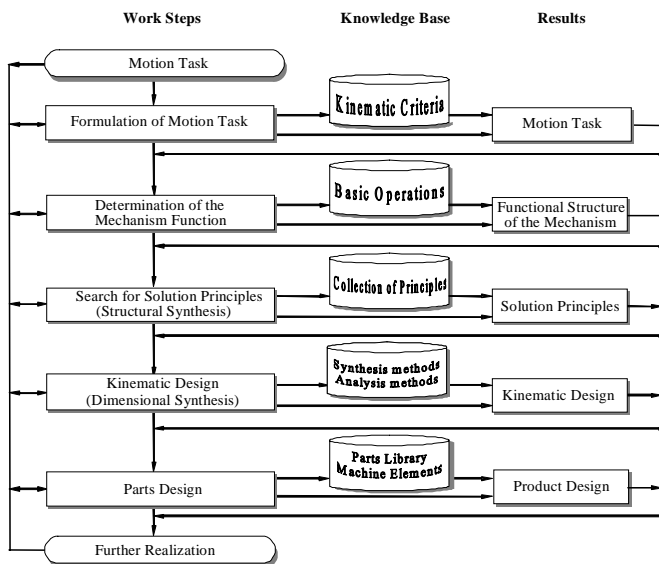

Fig. 2. Work steps for the design of mechanisms

Fig. 2 shows the different steps that have to be taken during the design of a mechanism. Additionally also the different means that can be used for the different steps are shown together with the results that can be achieved for each step. This is exactly where the IGM-Mechanism Encyclopaedia and the Digital Mechanism Library come into play. The IGM-Mechanism Encyclopaedia is based on the large model collection at the Institute for Mechanism Theory and Machine Dynamics (IGM) [6]. It is aimed at aiding the mechanism designer when developing solutions for given motion tasks. The main topic is the type synthesis of mechanisms [7] and therefore the encyclopaedia contains a collection of mechanism principles and a selection of mechanism examples taken from the large number of mechanism models as described in the following chapter.

2 MECHANISM MODEL COLLECTIONS

2.1 Mechanism collections and mechanism descriptions

The mechanism collection of the IGM is a collection of models that partly originate from different research topics and partly have been especially created for teaching purposes. Additionally it contains industry models of mechanisms from different areas of mechanical engineering. Fig. 3 shows part of the collection as presented in the public areas of the institute, Fig. 4 displays an arbitrarily chosen example of a mechanism, in this case a dwell mechanism.



Fig. 3. Display of model collection at the institute

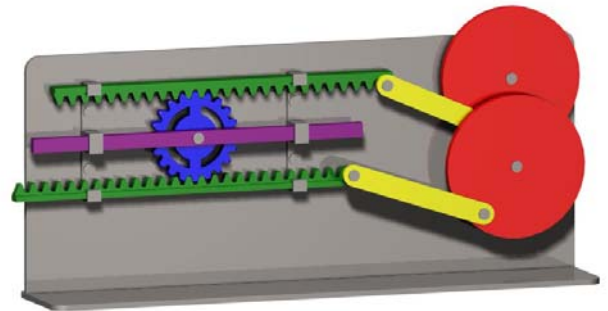

Fig. 4. Model of a dwell mechanism

In order to make the knowledge about the mechanism models available on a broader scale especially with regards to their purpose and their functionality, descriptions of the mechanism models have been made, which have been published in a German engineering periodical on a successive basis starting March 1988 [8]. Fig. 5 shows such a description for the mechanism model shown in Fig.4.

In the middle of the nineties of the last century these mechanism descriptions have been collected and published as a catalogue [9]. The mechanism descriptions contain three different pictures of the mechanism in different grades of abstractness. Besides a photo of the model or the exact mechanism a scaled kinematic schematic is presented. This allows to have an immediate visual impression of the mechanism and its design. Additionally the kinematic schematic contains all symbols such as link numbers, denomination of joints and definitions of angles. As most abstract representation the so called type schematic is presented

which not only shows the kinematic chain of the mechanism but also denotes the frame link as well as the input and output link together with an indication of the joint types.

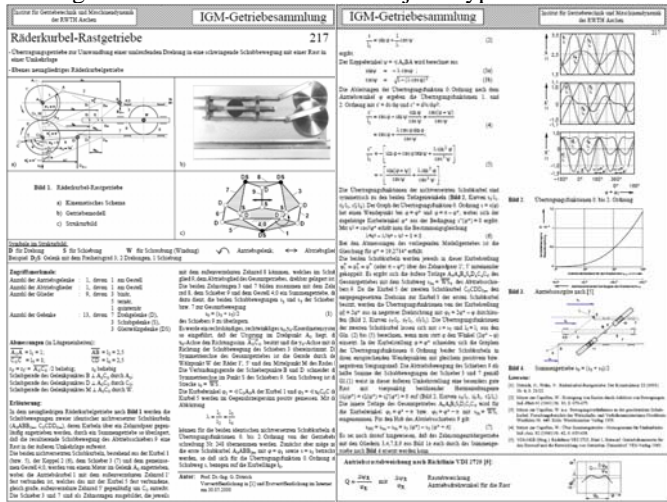

Fig. 5. IGM- Mechanism Model Description

As further information displayed in this part of the mechanism description, the kinematic dimensions of the mechanism model are presented. Additionally the functionality of the mechanism model is described in a short text. This enables the user to create variants of the described mechanism which may be better adapted to the specific requirements of his motion task which may differ slightly from the motion task performed by the described mechanism. Additional information such as relevant transfer functions up to second order or in case of positioning mechanisms information about the pose of the output link are given. Also if sensible, velocity and acceleration diagrams can be found. Depending on the motion task such as e.g. straight line motion, characteristic values such as quality coefficients are presented. Furthermore reference is made to relevant papers especially regarding kinematic variants and additional calculation procedures.

3 CONCEPT AND DESIGN OF THE IGM-MECHANISM ENCYCLOPAEDIA

The IGM-Mechanism Encyclopaedia is a derivation of the above mentioned mechanism descriptions and has been developed as a computer based design tool. It is meant to aid in designing kinematic solutions for a given motion task. By being a computer based system, the digital mechanism encyclopaedia has a lot of advantages as compared to traditional knowledge bases such as books or paper catalogues. With the digital mechanism encyclopaedia the knowledge relevant for the development and design of mechanisms can be displayed in different forms such as plain text, pictures, animations and interactive elements by using internet functionalities. The use of the computer in case of animations and interactive elements increases the clearness of the presented information. It also allows the user to influence the display of information and to request dedicated information. Especially with the realisation of a request system based on a dedicated data base, advantages as compared to a static paper based catalogue are evident. The digital mechanism encyclopaedia contains descriptions of

mechanism principles, presentations of mechanism types and the above mentioned mechanism descriptions. Additionally it contains selected termini of mechanism theory. The complete content of the IGM-Mechanism Encyclopaedia is divided into the areas Basics, Planar Mechanisms, Spherical Mechanisms and Spatial Mechanisms (Fig. 6).



Fig. 6. Concept of the IGM-Mechanism Encyclopaedia

3.1 Solution Principles and Solution Retrieval

In [7] a mechanism classification has been developed which allows to describe not only a given motion task but also the motion task performed by a certain mechanism. The description of a given motion task using the typical criteria of the mechanism classification, is the demand profile for those mechanisms that are potential candidates for properly solving the given task. Therefore it is sensible to describe the performance of existing mechanism examples such as the models described in the mechanism collection also with the help of the mechanism classification and using this as the resulting profile. Thus the criteria that describe the motion task can directly be used as selection criteria for potential mechanism solution. This functionality is realised within the mechanism encyclopaedia and simultaneously represents the basis of the integrated search form (Fig. 7).

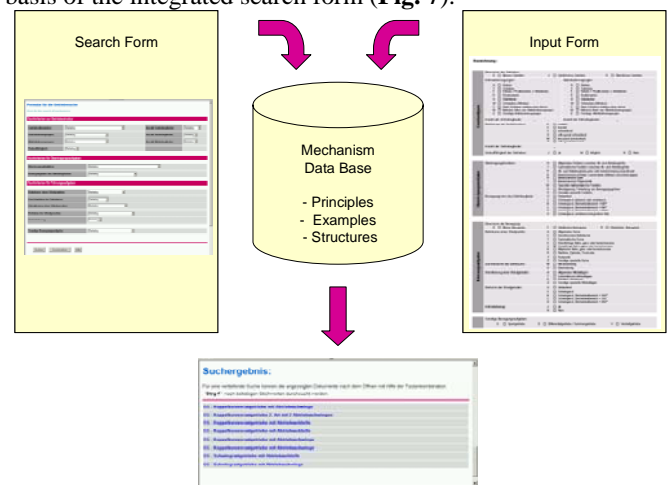

Fig. 7 Mechanism data base with Search Form and Input Form

It is both suited to search for a model mechanism as well as for a mechanism principle. Through the selection of applicable properties the user defines the search criteria for the following request. Then the content of the encyclopaedia is browsed according to the given search criteria. The output of such a search is a list of potential solutions. Basis of this search functionality is an integrated data base. All mechanism entries in the data base are characterized by their typical features according to the classification.

2.2 The virtual mechanism model collection

Catalogues of mechanisms are the sine-qua-non for a successful and precise design process [2] not only but especially for motion devices. Over the last years, different opinions how to approach this process have been established that brought up several ideas and requirements for a final solution [e.g. 3]. The essential requirement for a design catalogue is the completeness of the available solutions and if that is not completely warranted, the catalogue has to be named a “solution collection”.

The Association of German Engineers (VDI) set up a guideline [13] that sums up a number of existing catalogues as well as mechanism model collections, all different in their solution finding:

- Catalogues which include a very abstract view on the mechanism, such as diagrams and non-scaled graphics;
 - Catalogues that summarize mechanisms with certain motion characteristics, such as straight line motion etc. ;
 - Collections of already designed and produced mechanisms;
- In many cases, collections are arranged by their size instead of function, which complicates the quest for a certain mechanical or kinematic solution.

VDI guideline 2222 [2] does not demand on a systematic structure in a collection, but because of their function as a compilation of solutions, we established a solution-orientated system for the collection. The basic elements, on which the collection is based are as follows:

- Job-oriented structure, arranged by the existing mechanical problem [5]
- Listing of the kinematic and dynamic parameters, necessary to meet the conditions
- As far as possible: advanced sources or practical applications are specified

For the arrangement of the different mechanisms, the IGM collection uses structural and functional features such as motion characteristics or mechanism dimension (e.g. planar, spherical or spatial).

For the underlying database, the open-source program MySQL was used. This allows a relational database concept, containing a number of charts linked with each other in m:n relations. Also, the unique specifications of every mechanism are stored as well as the derivatives and their attributes. This includes not only the pictures and videos or animations, but also the CAX-models, pdf-sheets and CAD-files as well as other program files. All these digital sources are stored on the IGM-webserver, used by the program via links and downloadable for the user, enabling him to later work with the files offline. The connection between the virtual collection and the database is programmed with php that offers a fast and secure data access. Using dynamic html simplifies the handling for the user and allows a fast access. A protected admin control panel permits to

use an input blank in order to modify, extend or delete the current database by the administrator. Thus the possibility to enter an allmost endless number of new mechanisms and consequently even more metadata is given.

The virtual mechanism model collection today contains 230 of 250 mechanisms, existing at IGM and will be completed during summer 2006. It is free and accessible through the IGM webpage [14] for any computer, connected to the WWW.



Fig. 8. The search engine of the virtual mechanism collection

A detailed search engine (Fig. 8) allows to enter several characteristics to look for, such as more than ten different structural criteria as well as motion attributes. Fig. 8 shows a practical example of how to use the search engine to find a specific solution:

A machine-tool requires a mechanism to control the feed automatically and stop by at a default point. Now several inputs for the search engine must be defined: The mechanism has to be ‘planar’ (1), the input link must be able to ‘rotate completely’ (2). The input motion must be ‘rotation’ (3) and the output should be a ‘rectilinear translation’ (4). The input and output links need to be ‘parallel’ (5) and because of the function to keep the position, it has to be a ‘dwell mechanism’ (6). Finally the degree of mobility (7) and the number of input links (8) both should be ‘one’. With that information the virtual mechanism collection provides seven mechanisms that fit the parameters above. For a quick and timesaving data retrieval, the relating stocking numbers and positions in the IGM mechanism collection are stated, too.

3.2 Interactive features

While evaluating a potential solution it might be advantageous to start with a preliminary layout in order to better evaluate potential mechanisms. Within the IGM-Mechanism Encyclopaedia there are a number of different graphical synthesis and analysis methods available which can be used in this early design stage. A lot of the graphical methods can be applied through computer based geometry programs. One such program is the interactive geometry program Cinderella [10]. In a simple and intuitive way this program eases the realization of geometric methods on the computer. It is a mouse driven geometry program, where elements of the geometric design can

be picked with the cursor and be moved to different positions with the rest of the geometric design following that change in position in a geometry consistent way. Thus the behaviour of the geometric design can be explored by the user in a very intuitive way [11]. An additional feature of this program is the presentation of geometric locus curves, a feature that opens up a bunch of possibilities in mechanism theory. For example this functionality allows a very easy realization of the display of coupler curves but even centrodes or centre-point curves can be displayed.

For further kinematic analysis of planar mechanism the program KINTOP has been developed. With this program all motion parameters such as position, velocity and acceleration of all mechanism links can be determined and displayed together with an animation of the motion behaviour. Additionally motion paths, velocity and acceleration vectors of arbitrary points can be displayed as well as velocity hodographs. For many of the mechanisms contained within the library data sets for use with this program are available. Thus the functionality of the mechanism and its performance even with new values for the kinematic parameters can be visualized such that the mechanism designer can judge the performance with regard to his motion task.

4 CONCEPT OF THE DIGITAL MECHANISM LIBRARY (DMG-LIB)

As already mentioned the Digital Mechanism Library is the much larger cousin of the IGM-Mechanism Encyclopaedia. It is also internet based and enhances the presentation of mechanisms by using multimedia documents with additional information such as synthesis methods, analysis results, animations and hyperlinks [12].

The composition of this worldwide accessible digital library for mechanism and machine science started in 2004 in order to counteract the creeping decline in accessible knowledge in that area. The goals of DMG-Lib are the collection, conservation classification, cross-linking and suitable presentation of the still extensive knowledge about mechanism and machine science. This does not only include the presentation of text documents and pictures but also presentations through computer based functional models based on mechanism models such as described in chapter 2. Such models exist in large 4 digit numbers in different locations, especially universities but also museums. Often they are available to the public only in a very restricted way or even not at all. DMG-Lib is sponsored by the German Research Fund (DFG) within a specialized research initiative called „Performance Centre for Research Information“. The interdisciplinary collaboration is headed by the department of Engineering Design of the Technical University Ilmenau. Additionally the departments of Mechanism Theory, Graphical Information Technology, and Media Production of the Technical University Ilmenau together with the university library, the patent research center and university's IT department are taking part in the project. The departments for mechanism theory at the Technical University Dresden and RWTH Aachen University are major contributors with regards to their expertise in mechanism theory.

All documents and information collected within DMG-Lib can be efficiently retrieved with problem oriented retrieval criteria. Thus a transition from a static to a dynamic and

problem oriented provision of knowledge can be achieved and consequently a dynamic data base for mechanism and machine theory and related engineering areas can be pushed forward. Typical sources are shown in Fig. 9.

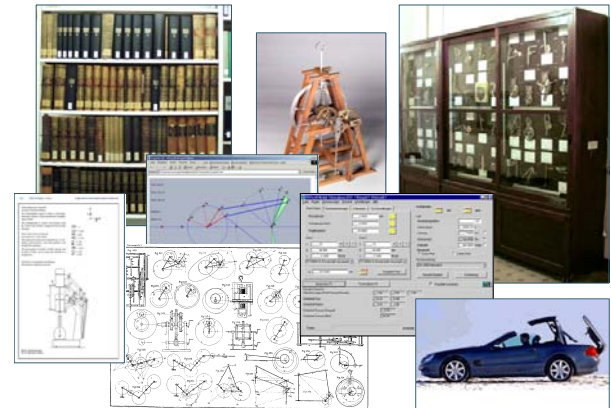

Fig. 9 Typical data sources for DMG-Lib [12]

Even though digitizing and internet based presentation already eases the access towards certain documents, a proactive, user oriented and efficient solution retrieval for given engineering tasks is not yet fully accomplished in existing technical data bases. Digitizing efforts, which are the scope of many data bases, are of course necessary but not sufficient for an efficiently accessible database that should act as the kernel of a performance centre for research information.

In order to fulfil such requirements more than just a collection of digitized documents or links to relevant internet pages must be offered. The new quality of DMG-Lib is realized by using an enhancement of the data base structure described in chapter 3.1 based on the abstract description of mechanism solutions and the digital storage in a unified data format. The abstraction is based on determining the underlying technical principle. Through the unified description of a variety of technical principles and a subsequent analysis of motion solutions based on these unified descriptions a systematic data base can be built up, which can efficiently be browsed for potential solutions. Additional features of DMG-Lib are listed as follows:

- constraint-based modelling of mechanisms as a basis for the generation of a variety of additional data formats
- provision of different description levels (verbal, analytical, graphical) for mechanisms and machines to ensure scalability for different levels of access and changing user demands
 - textual descriptions of use and benefit,
 - pixel graphics for visual impression,
 - animated pixel graphics, Java-animation, Flash-animation, VRML,
 - additional descriptions such as data sets with connection to existing analysis, synthesis and optimization programs,
 - constraint-based descriptions,
- platform spanning representation through the internet for a broad public in a scaled manner allowing access for different purposes such as teaching, self learning, research and product design
- Development of a knowledge data base, which supports

- type synthesis of mechanisms
- Provision of automatic access to library content through the use of different user oriented descriptors / meta data using new standardized formats such as RDF-format
- Support of synthesis and optimization tasks in engineering research and development

The procedure from the allocation of relevant data sources up to the presentation within the internet portal of DMG-Lib is shown in Fig. 11.

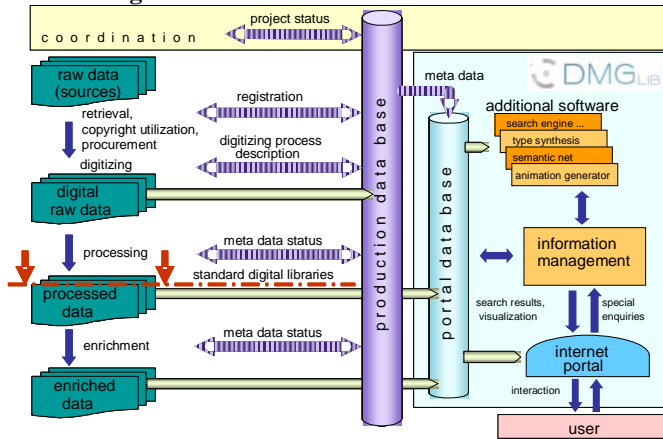

Fig. 10 Concept of data processing for the DMG-Lib internet portal [12]

As shown in Fig. 9 the data sources for DMG-Lib are very extensive and diverse. They encompass functional models, mechanism catalogues, technical reports, research reports, text books, scientific papers, conference proceedings, videos, photos etc. All these sources must be procured preferably in original format, digitized and converted in suitable formats. In contrast to other projects dealing with digital libraries, where only the digital raw data are made available, the major task within DMG-Lib project is the conditioning, preparation and enrichment of the digital raw data with additional information such as textual descriptions, animated illustrations or constraint based models. Thus the motion behaviour of a mechanism can be visualized and additional simulations and analysis can be performed. All this allows a target oriented and efficient dynamic access to the contents of DMG-Lib.

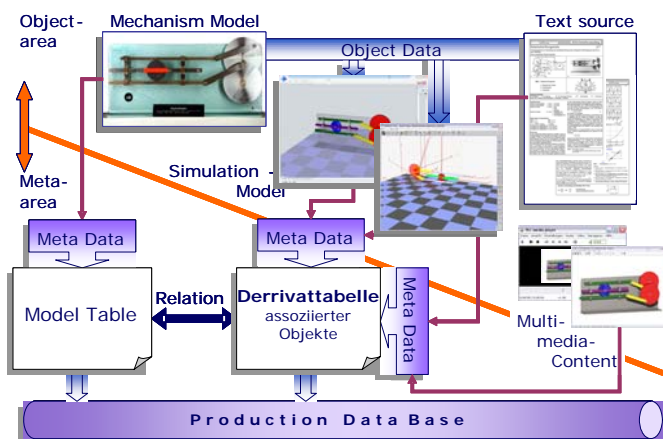

Fig. 11 Meta data organisation for a mechanism model

The functionality of the mechanism data base is presented in Fig. 11. The basic data are pictures of the functional model and the textual description of its functionality and design. Additionally further documents such as videos, animations and simulation models can be found. All available meta data are inserted into the dedicated tables of the data base. Via an additional table, the concept of the relational data base allows it to allocate all associated documents and files to a mechanism model.

The access is realized through an international portal which allows researchers, mechanical designers, engineering students and others interested in mechanisms access to the complete knowledge base through diverse aspects.

4 SUMMARY

The main functionality of the IGM-Mechanism Encyclopaedia and on an even broader scale of DMG-lib is the display of expertise and know-how in the field of mechanism theory. Related information such as mechanism principles, examples of mechanisms and the basics of mechanism theory can be accessed with the computer. Additionally the computer-aided search of suitable solutions for a given motion task is supported. A classification based on the analysis both of motion tasks and mechanism examples has been integrated into a selection form, which allows to start a data base inquiry in order to retrace the related information stored within the mechanism library. Besides displaying expertise and know-how in the field of mechanism theory also the immediate application of expertise is supported. This is realized by integrating software for the synthesis and analysis of mechanisms. Through the use of modern internet technology a very efficient design tool has been started that fulfils not only the requirements of mechanism analysis but much more the specific requirements of mechanism synthesis.

REFERENCES

- [1] Niemeyer, J.: Das IGM-Getriebelexikon - Wissensverarbeitung in der Getriebetechnik mit Hilfe der Internet-Technologie. In: Dittrich, G. (Hrsg.): IGM-Kolloquium Getriebetechnik 2000, Forschung & Lehre 1972-2000. Aachen: Mainz 2000, S. 53-66.
- [2] VDI-EKV: Richtlinie VDI 2222 Bl.1. Konstruktionsmethodik. Methodisches Entwickeln von Lösungsprinzipien. Düsseldorf: VDI-Verlag 1997.
- [3] Pahl, G.; Beitz, W.: Konstruktionslehre. Methoden und Anwendungen, 3. Auflage. Berlin: Springer-Verlag 1993.
- [4] Koller, R.: Konstruktionslehre für den Maschinenbau, 3., völlig neu bearbeitete und erweiterte Auflage. Berlin: Springer-Verlag 1994.
- [5] Dittrich, G.: Systematik der Bewegungsaufgaben und grundsätzliche Lösungsmöglichkeiten. VDI-Berichte Nr. 576, S. 1- S. 20. Düsseldorf: VDI-Verlag 1985.
- [6] Corves, B., Niemeyer, J. : Das IGM-Getriebelexikon als Instrument der Wissensverarbeitung in der Getriebetechnik. Proceedings of the IX. International Conference on the Theory of Machines and Mechanism, August 31 – Sept. 2, 2004, Liberec, Czech Republic.
- [7] Niemeyer, J.: Methodische Entwicklung von Prinziplösungen bei der Auslegung ungleichmäßig

- übersetzender Getriebe unter Verwendung eines praxisorientierten interaktiven Wissensspeichers. Dissertation RWTH Aachen: Shaker-Verlag, 2003.
- [8] Dittrich, G.; Wehn, V.: Getriebetechnische Lösungssammlung. Der Konstrukteur 19 (1988) Nr. 3, S. 85-88.
- [9] Dittrich, G.; et al.: IGM-Getriebesammlung. Aachen 1995.
- [10] Richter-Gebert, J.; Kortenkamp, K.H.: The Interactive Geometry Software Cinderella. Berlin: Springer 2000.
- [11] Corves, B.: Computer-aided Lectures and Exercises: Graphical Analysis and Synthesis in Mechanism Theory. Proceedings of the 11th World Congress in Mechanism and Machine Science, Vol.2, April 1-4, 2004, Tianjin, China: China Machine Press, 2004.
- [12] Döring, U.; Brix, T. und Reeßing, M.: Application of Computational Kinematics in the Digital Mechanism and Gear Library DMG-Lib, Proceedings of CK2005, International Workshop on Computational Kinematics, Cassino, 2005.
- [13] VDI-Code 2727 Blatt 1 bis 4: Entwurf: Lösung von Bewegungsaufgaben mit Getrieben, Düsseldorf, VDI-Verlag 1991/2000.
- [14] <http://www.igm.rwth-aachen.de/getriebemodell-sammlung/home/index.php>